

Industrial Curtain Wall Hardware

Roller Tracks

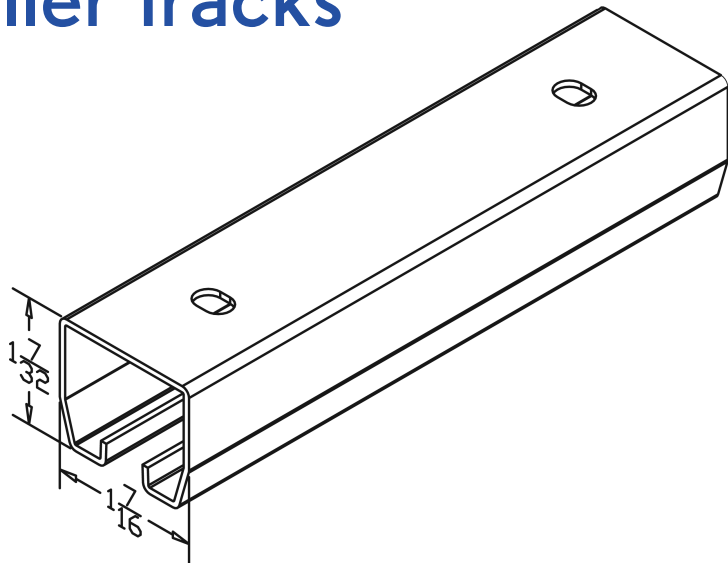

- Available up to 20 ft. long
- 16 Gauge Galvanized Steel (Standard)
- 12 Gauge Steel (Available)
- Stainless Steel (Available)
- Made in the USA

Additional Roller Track Hardware

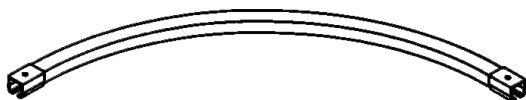

Plain Curved Track

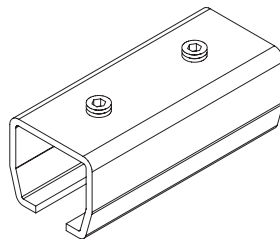

Plain Curved Track Connector

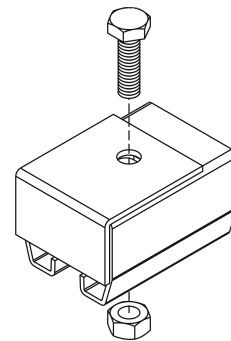

Plain Track End Stop

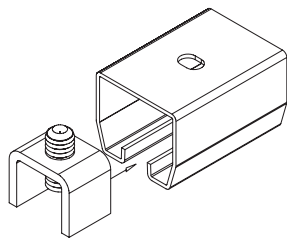

Adjustable Track End Stop

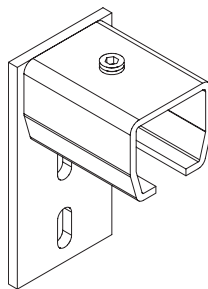

Wall Mount End Stop - Flange Down

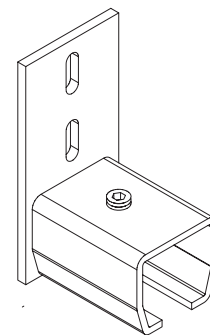

Wall Mount End Stop - Flange Up